

**Product Specification**

	Model: GKCY43TNAH2E0	Rev. No.	Issued Date.	Page.
		A	2015,Jan,27	1 / 24

**Thin-Film-Transistor LCD Module  
Model: GKCY43TNAH2E0**

Acceptance

**Solomon Goldentek Display Corp.  
NO. 18 Ta-Yeh St., Ta-Fa Industrial Park, Ta-Liao  
Hsiang, Kaohsiung Hsien 831, TAIWAN , R.O.C.  
FAX: 886-7-7886800**

Approved and Checked by

Approved by	Checked by		Made by



## Product Specification

	Model: GKCY43TNAH2E0	Rev. No.	Issued Date.	Page.
		A	2015,Jan,27	3 / 24

## Contents

<b>1</b>	<b>General Description and Features</b> .....	<b>4</b>
1.1	Features	4
1.2	LCD Module	4
<b>2</b>	<b>Mechanical Information</b> .....	<b>5</b>
<b>3</b>	<b>Electrical Specifications</b> .....	<b>6</b>
3.1	Absolute Max. Ratings	6
3.2	Electrical Absolute Rating	6
<b>4</b>	<b>Electrical Characteristics</b> .....	<b>7</b>
4.1	TFT-LCD Module	7
4.2	Backlight Unit	7
<b>5</b>	<b>Block Diagram</b> .....	<b>8</b>
<b>6</b>	<b>Input Terminal Pin Assignment</b> .....	<b>9</b>
6.1	CN1 Pin Assignment	9
<b>7</b>	<b>Optical Characteristics</b> .....	<b>11</b>
<b>8</b>	<b>Basic Display Color and Gray Scale</b> .....	<b>14</b>
<b>9</b>	<b>AC Timing</b> .....	<b>15</b>
9.1	AC Characteristics	15
9.2	Parallel RGB Input Timing Table	16
9.3	POWER ON/OFF SEQUENCE	18
<b>10</b>	<b>Test</b> .....	<b>19</b>
<b>11</b>	<b>Dimensional outlines</b> .....	<b>20</b>
<b>12</b>	<b>Incoming Inspection Standards</b> .....	<b>21</b>

## Product Specification

	Model: GKCY43TNAH2E0	Rev. No.	Issued Date.	Page.
		A	2015,Jan,27	4 / 24

### 1 General Description and Features

GKCY43TNAH2E0 is a TM (Transmissive) type color active matrix TFT (Thin Film Transistor) liquid crystal display (LCD) that uses amorphous silicon TFT as a switching device. This model is composed of a TFT-LCD module, a driver circuit and a back-light unit. The resolution of a 4.3" contains 480(RGB)x272 dots and can display up to 16.7M colors. The following table described the features of GKCY43TNAH2E0.

#### 1.1 Features

- Transmissive and back-light with 12 LEDs are available.
- TN (Twisted Nematic) mode.
- 24bit RGB Interface
- ROHS Compliance

#### 1.2 LCD Module

Item	Specification	Unit
Screen Size	4.3 inches	Diagonal
Display Resolution	480(H) x RGB x 272(V)	Dot
Pixel size	0.198 (H) x 0.198 (V)	mm
Active Area	95.040 (H) x 53.856 (V)	mm
Outline Dimension	105.5 (W) x 67.2 (H) x 3.95 (D)	mm
Display Mode	Normally white/Transmissive	--
Pixel Arrangement	RGB Vertical-Stripe	--
Surface Treatment	Anti-glare (AG)	--
Display Color	16.7M	--
Viewing Direction (Gray Inversion)	6 o'clock (Gray Inversion)	--
Input Interface	Digital 24-bits parallel RGB	--

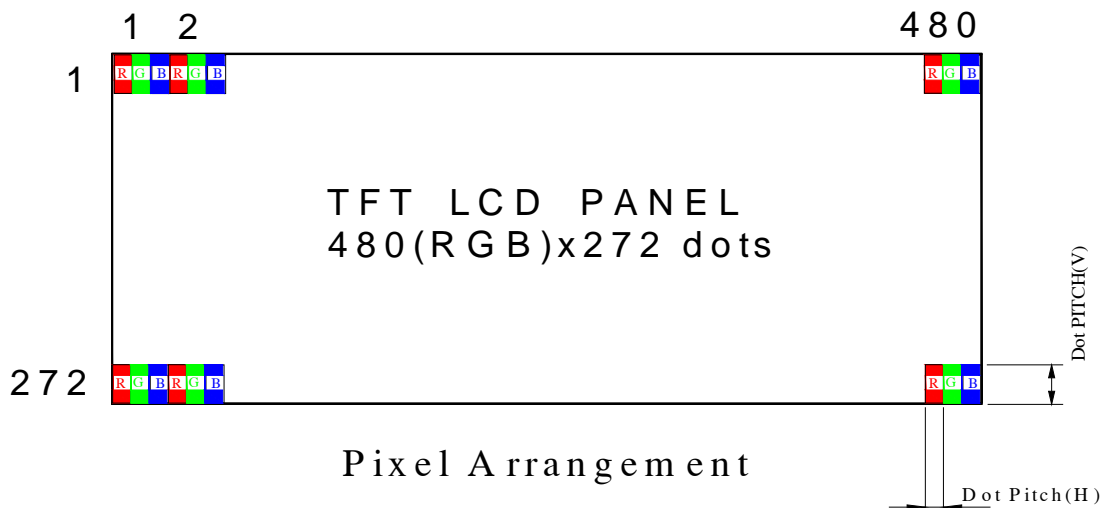

## Product Specification

	Model: GKCY43TNAH2E0	Rev. No.	Issued Date.	Page.
		A	2015,Jan,27	5 / 24

### 2 Mechanical Information

Item		Min.	Typ.	Max.	Unit	Note
Module Size	Horizontal (H)	--	105.5	--	mm	--
	Vertical (V)	--	67.20	--	mm	(1)
	Thickness (T)	--	3.95	--	mm	(1)
Weight		--	60	--	g	--

Note (1) Not include FPC.

Refer to the Dimensional Outlines for further information.

## Product Specification

	Model: GKCY43TNAH2E0	Rev. No.	Issued Date.	Page.
		A	2015,Jan,27	6 / 24

### 3 Electrical Specifications

#### 3.1 Absolute Max. Ratings

##### 3.1.1 Absolute Ratings of Environment

If the operating condition exceeds the following absolute maximum ratings, the TFT LCD module may be damaged permanently.

(Ta=25±2°C, V<sub>SS</sub>=GND=0)

Item	Symbol	Min.	Max.	Unit	Note
Storage temperature	T <sub>STG</sub>	-30	85	°C	(1)
Operating temperature	T <sub>OPR</sub>	-30	85	°C	(1,2,3)

Note (1) 90 % RH Max. ( 40 °C ≥ Ta ). Maximum wet-bulb temperature at 39 °C or less. (Ta > 40 °C) No condensation.

Note (2) In case of below 0°, the response time of liquid crystal (LC) becomes slower and the color of panel becomes darker than normal one. Level of retardation depends on temperature, because of LC's character

Note (3) Only operation is guaranteed at operating temperature. Contrast, response time, another display quality are evaluated at +25°C.

#### 3.2 Electrical Absolute Rating

##### 3.2.1 TFT-LCD Module

(Ta=25±2°C, V<sub>SS</sub>=GND=0)

Item	Symbol	Value		Unit	Condition
		Min.	Max.		
Power supply voltage	V <sub>DD</sub>	-0.3	4.5	V	

##### 3.2.2 Back-Light Unit

(Ta=25±2°C)

Item	Symbol	Min.	Max.	Unit	Note
Current of One LED	I <sub>LED</sub>	--	25	mA	(1)

Note (1) Permanent damage to the device may occur if maximum values are exceeded or reverse voltage is loaded. Functional operation should be restricted to the conditions described under normal operating conditions.

## Product Specification

	Model: GKCY43TNAH2E0	Rev. No.	Issued Date.	Page.
		A	2015,Jan,27	7 / 24

### 4 Electrical Characteristics

#### 4.1 TFT-LCD Module

(Ta=25±2°C, V<sub>DD</sub> =3.3V)

Item	Symbol	Value			Unit	Condition
		Min.	Typ.	Max.		
Power supply voltage	V <sub>DD</sub>	3.0	3.3	3.6	V	
Input Voltage for logic	H Level	0.7xV <sub>DD</sub>	-	V <sub>DD</sub>	V	
	L Level	0	-	0.3xV <sub>DD</sub>	V	
Digital Current	I <sub>DD</sub>	-	15	18	mA	

Note (1) The specified power consumption is under the conditions at V<sub>CC</sub>=3.3V , F<sub>V</sub>=60Hz, whereas a Power dissipation check pattern below is displayed.

Black Pattern / 0 Gray

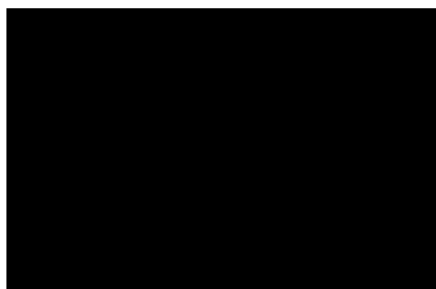

Active Area

#### 4.2 Backlight Unit

The back-light system is an edge-lighting type with white LED (Light Emitting Diode)s.

(Ta=25±2°C)

Item	Symbol	Value			Unit	Condition
		Min.	Typ.	Max.		
LED Voltage	V <sub>L</sub>	-	19.8	21	V	
LED Current	I <sub>f</sub>	-	40	50	mA	
Power Consumption	P <sub>BL</sub>	-	792	1050	mW	(2)
LED Life Time (25°C)	-	50000	-	-	hr	(3)

Note :(1) 6 LEDs serial 2 parallel type.

(2) Where I<sub>f</sub> = 40mA, V<sub>L</sub> = 19.8V, P<sub>BL</sub> = V<sub>L</sub> × I<sub>f</sub>

(3)The environmental conducted under ambient air flow ,at Ta=25±2°C,60%RH±5%

## Product Specification

	Model: GKCY43TNAH2E0	Rev. No.	Issued Date.	Page.
		A	2015,Jan,27	8 / 24

### 5 Block Diagram

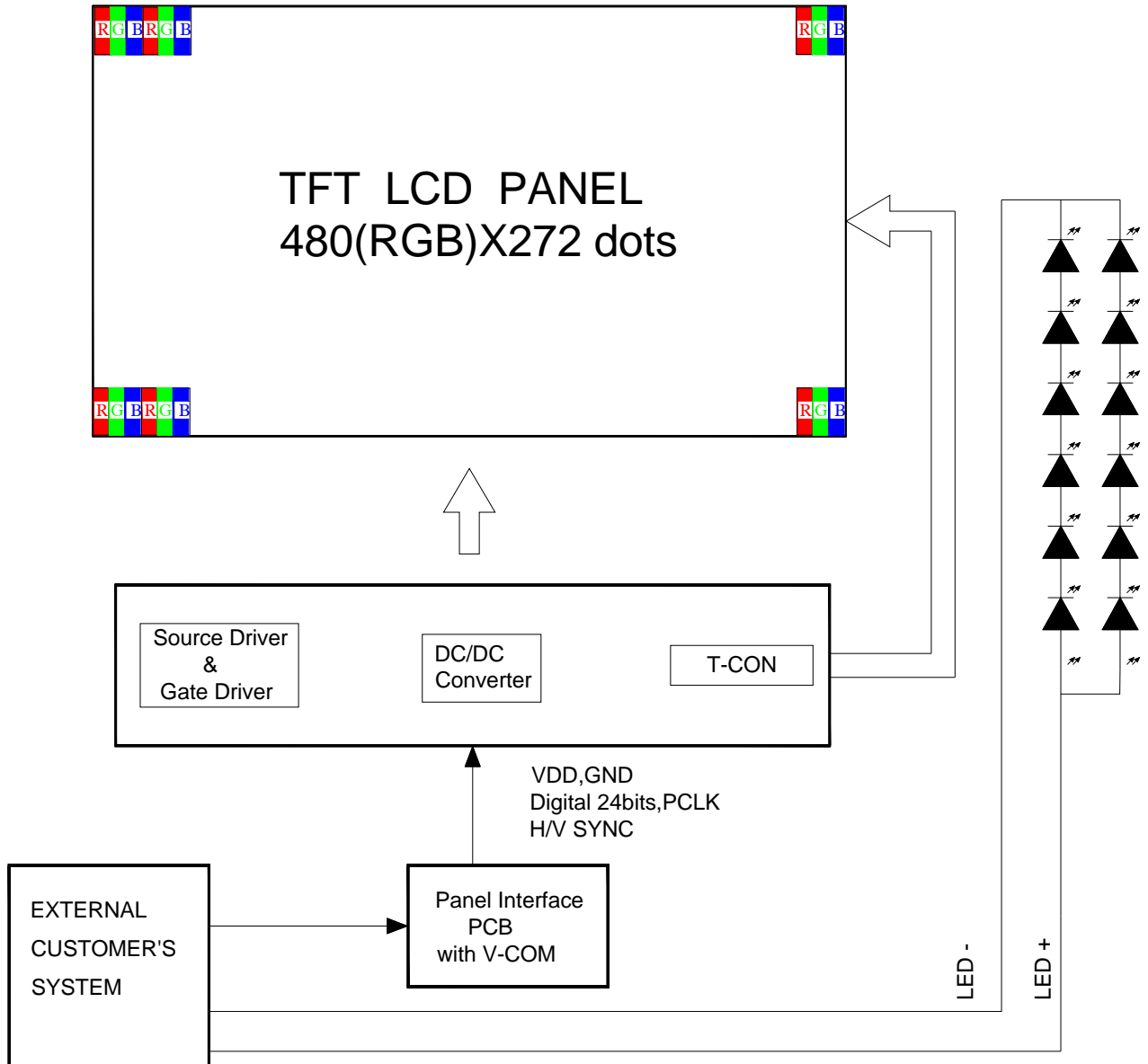



## Product Specification

	Model: GKCY43TNAH2E0	Rev. No.	Issued Date.	Page.
		A	2015,Jan,27	9 / 24

### 6 Input Terminal Pin Assignment

#### 6.1 CN1 Pin Assignment

(Reference Connector: Hirose Electric Co., LTD. Product No. FH12A-40S-0.5SH(55) Top contact type)

Pin No.	Symbol	I/O	Function	Remark
1	VSS	P	Ground	
2	VSS	P	Ground	
3	V <sub>DD</sub>	P	Logic power supply(+3.0~3.6V)	
4	V <sub>DD</sub>	P	Logic power supply(+3.0~3.6V)	
5	R0	I	Red Data Bit 0(LSB)	
6	R1	I	Red Data Bit 1	
7	R2	I	Red Data Bit 2	
8	R3	I	Red Data Bit 3	
9	R4	I	Red Data Bit 4	
10	R5	I	Red Data Bit 5	
11	R6	I	Red Data Bit 6	
12	R7	I	Red Data Bit 7(MSB)	
13	G0	I	Green Data Bit 0(LSB)	
14	G1	I	Green Data Bit 1	
15	G2	I	Green Data Bit 2	
16	G3	I	Green Data Bit 3	
17	G4	I	Green Data Bit 4	
18	G5	I	Green Data Bit 5	
19	G6	I	Green Data Bit 6	
20	G7	I	Green Data Bit 7(MSB)	
21	B0	I	Blue Data Bit 0 (LSB)	
22	B1	I	Blue Data Bit 1	
23	B2	I	Blue Data Bit 2	
24	B3	I	Blue Data Bit 3	
25	B4	I	Blue Data Bit 4	
26	B5	I	Blue Data Bit 5	
27	B6	I	Blue Data Bit 6	
28	B7	I	Blue Data Bit 7(MSB)	
29	VSS	P	Ground	
30	P <sub>CLK</sub>	I	Dot Data Clock	

## Product Specification

	Model: GKCY43TNAH2E0	Rev. No.	Issued Date.	Page.
		A	2015,Jan,27	10 / 24

31	DISP	I	Display on/off	
32	H <sub>SYNC</sub>	I	Horizontal Sync Input	
33	V <sub>SYNC</sub>	I	Vertical Sync Input	
34	DE	I	Data Enable	
35	NC	-	No Connect	
36	NC	-	No Connect	
37	NC	-	No Connect	
38	NC	-	No Connect	
39	LEDK	P	Backlight Cathode	
40	LEDA	P	Backlight Anode	

## Product Specification

	Model: GKCY43TNAH2E0	Rev. No.	Issued Date.	Page.
		A	2015,Jan,27	11 / 24

### 7 Optical Characteristics

The following items are measured under stable conditions. The optical characteristics should be measured in a dark room  
 Measuring equipment: BM-7A

(Ta=25±2°C , VDD =3.3V, I<sub>f</sub>=40mA)

Item		Symbol	Condition	Min	Type	Max	Unit	Note
Brightness		--	--	800	950	--	cd/m <sup>2</sup>	--
Response time		T <sub>R</sub>	θ=0°	--	5	10	ms	--
		T <sub>F</sub>		--	15	20	ms	
Contrast ratio		CR	At optimized viewing angle	250	350	--	--	--
Color Chromaticity	Red	R <sub>X</sub>	θ=0° Normal Viewing Angle	0.57	0.62	0.67	--	--
		R <sub>Y</sub>		0.29	0.34	0.39		
	Green	G <sub>X</sub>		0.29	0.34	0.39	--	
		G <sub>Y</sub>		0.52	0.57	0.62		
	Blue	B <sub>X</sub>		0.09	0.14	0.19	--	
		B <sub>Y</sub>		0.05	0.10	0.15		
	White	W <sub>X</sub>		0.27	0.32	0.37	--	
		W <sub>Y</sub>		0.29	0.34	0.39		
Viewing Angle (6H)	Hor.	θ <sub>R</sub>	CR≥10	50	65	Degree	--	
		θ <sub>L</sub>		50	65			
	Ver.	θ <sub>U</sub>		40	50			
		θ <sub>D</sub>		50	60			

## Product Specification

	Model: GKCY43TNAH2E0	Rev. No.	Issued Date.	Page.
		A	2015,Jan,27	12 / 24

a. Test equipment setup

After stabilizing and leaving the panel alone shall be warmed up for the stable operation of LCM, the measurement should be executed. Measurement should be executed in a stable, windless, and dark room. Optical specifications are measured by Topcon BM-5A/BM-7(fast) with a viewing angle of 2° at a distance of 50cm and normal direction.

b. Definition of response time: Tr and Tf

The response time is defined as the following figure and shall be measured by switching the input signal for "black" and "white".

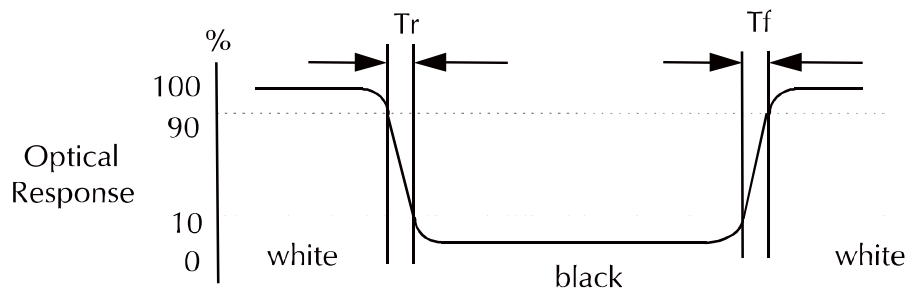

c. Definition of contrast ratio:

Brightness measured when LCD is at "white state"

$$\text{Contrast Ratio (CR)} = \frac{\text{Brightness measured when LCD is at "white state"}}{\text{Brightness measured when LCD is at "black state"}}$$

Brightness measured when LCD is at "black state"

d. Measured at the center area of the panel when all the input terminals of LCD panel are electrically opened.

## Product Specification

	Model: GKCY43TNAH2E0	Rev. No.	Issued Date.	Page.
		A	2015,Jan,27	13 / 24

e. View Angle

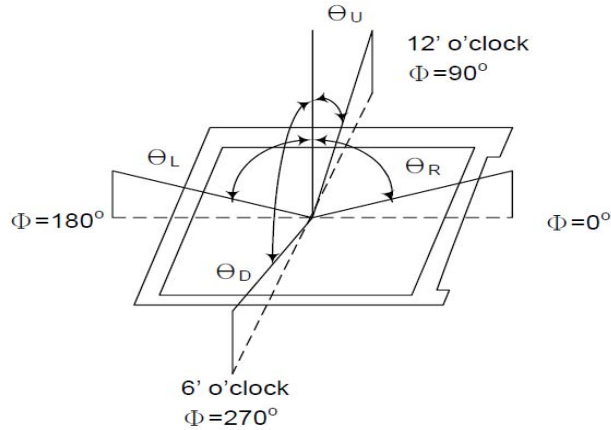

f. Definition of Luminance of White: Luminance of white at the center points

Light Source of Back-Light Unit	LED Type
---------------------------------	----------

g. Definition of White Uniformity

$$\text{White Uniformity} = \frac{\text{Min. luminance of white among 9-points}}{\text{Max. luminance of white among 9-points}} \times 100\%$$

h. The definition of Color Gamut -Color Chromaticity CIE 1931

Color coordinate of white & red, green, blue at center point.

$$\text{Color Gamut : NTSC(\%)} = ( \text{RGB Triangle Area} / \text{NTSC Triangle Area} ) \times 100$$

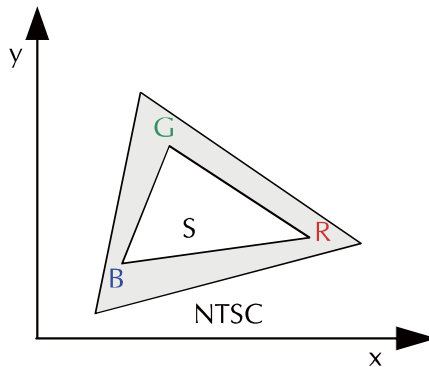

## Product Specification

	Model: GKCY43TNAH2E0	Rev. No.	Issued Date.	Page.
		A	2015,Jan,27	14 / 24

### 8 Basic Display Color and Gray Scale

	Color & Gray Scale	Data Signal																							
		R7	R6	R5	R4	R3	R2	R1	R0	G7	G6	G5	G4	G3	G2	G1	G0	B7	B6	B5	B4	B3	B2	B1	B0
Basic Color	Black	0	0	0	0	0	0	0	0	0	0	0	0	0	0	0	0	0	0	0	0	0	0	0	0
	Red	1	1	1	1	1	1	1	1	0	0	0	0	0	0	0	0	0	0	0	0	0	0	0	0
	Green	0	0	0	0	0	0	0	0	1	1	1	1	1	1	1	1	0	0	0	0	0	0	0	0
	Blue	0	0	0	0	0	0	0	0	0	0	0	0	0	0	0	0	1	1	1	1	1	1	1	1
	Cyan	0	0	0	0	0	0	0	0	1	1	1	1	1	1	1	1	1	1	1	1	1	1	1	1
	Magenta	1	1	1	1	1	1	1	1	0	0	0	0	0	0	0	0	1	1	1	1	1	1	1	1
	Yellow	1	1	1	1	1	1	1	1	1	1	1	1	1	1	1	1	0	0	0	0	0	0	0	0
	White	1	1	1	1	1	1	1	1	1	1	1	1	1	1	1	1	1	1	1	1	1	1	1	1
Red	Black	0	0	0	0	0	0	0	0	0	0	0	0	0	0	0	0	0	0	0	0	0	0	0	
	Red(1)	0	0	0	0	0	0	0	1	0	0	0	0	0	0	0	0	0	0	0	0	0	0	0	
	Red(2)	0	0	0	0	0	0	1	0	0	0	0	0	0	0	0	0	0	0	0	0	0	0	0	
	:	:	:	:	:	:	:	:	:	:	:	:	:	:	:	:	:	:	:	:	:	:	:	:	:
	Red(127)	0	1	1	1	1	1	1	1	0	0	0	0	0	0	0	0	0	0	0	0	0	0	0	
	:	:	:	:	:	:	:	:	:	:	:	:	:	:	:	:	:	:	:	:	:	:	:	:	:
	Red(254)	1	1	1	1	1	1	1	0	0	0	0	0	0	0	0	0	0	0	0	0	0	0	0	
	Red(255)	1	1	1	1	1	1	1	1	0	0	0	0	0	0	0	0	0	0	0	0	0	0	0	
Green	Black	0	0	0	0	0	0	0	0	0	0	0	0	0	0	0	0	0	0	0	0	0	0	0	
	Green(1)	0	0	0	0	0	0	0	0	0	0	0	0	0	0	0	1	0	0	0	0	0	0	0	
	Green(2)	0	0	0	0	0	0	0	0	0	0	0	0	0	0	1	0	0	0	0	0	0	0	0	
	:	:	:	:	:	:	:	:	:	:	:	:	:	:	:	:	:	:	:	:	:	:	:	:	:
	Green(127)	0	0	0	0	0	0	0	0	0	1	1	1	1	1	1	1	0	0	0	0	0	0	0	
	:	:	:	:	:	:	:	:	:	:	:	:	:	:	:	:	:	:	:	:	:	:	:	:	:
	Green(254)	0	0	0	0	0	0	0	0	1	1	1	1	1	1	1	0	0	0	0	0	0	0	0	
	Green(255)	0	0	0	0	0	0	0	0	1	1	1	1	1	1	1	1	0	0	0	0	0	0	0	
Blue	Black	0	0	0	0	0	0	0	0	0	0	0	0	0	0	0	0	0	0	0	0	0	0	0	
	Blue(1)	0	0	0	0	0	0	0	0	0	0	0	0	0	0	0	0	0	0	0	0	0	0	1	
	Blue(2)	0	0	0	0	0	0	0	0	0	0	0	0	0	0	0	0	0	0	0	0	0	0	1	
	:	:	:	:	:	:	:	:	:	:	:	:	:	:	:	:	:	:	:	:	:	:	:	:	:
	Blue(127)	0	0	0	0	0	0	0	0	0	0	0	0	0	0	0	0	0	1	1	1	1	1	1	
	:	:	:	:	:	:	:	:	:	:	:	:	:	:	:	:	:	:	:	:	:	:	:	:	:
	Blue(254)	0	0	0	0	0	0	0	0	0	0	0	0	0	0	0	0	1	1	1	1	1	1	0	
	Blue(255)	0	0	0	0	0	0	0	0	0	0	0	0	0	0	0	0	1	1	1	1	1	1	1	

0 : Low level voltage, 1 : High level voltage

Each basic color can be displayed in 256 gray scales from 8 bit data signals. With the combination of total 24 bit data signals, the 16,777,216-color display can be achieved on the screen.

# Product Specification

	Model: GKCY43TNAH2E0	Rev. No.	Issued Date.	Page.
		A	2015,Jan,27	15 / 24

## 9 AC Timing

### 9.1 AC Characteristics

Parameter	Symbol	Min	Typ	Max	Unit
DISP setup time	tdiss	10	-	-	ns
DISP hold time	tdish	10	-	-	ns
Clock period	PWCLK(1)	66.7	-	-	ns
Clock pulse high period	PWH(1)	26.7	-	-	ns
Clock pulse low period	PWL(1)	26.7	-	-	ns
Hsync setup time	t <sub>hs</sub>	10	-	-	ns
Hsync hold time	t <sub>hh</sub>	10	-	-	ns
Data setup time	t <sub>ds</sub>	10	-	-	ns
Data hold time	t <sub>dh</sub>	10	-	-	ns
DE setup time	t <sub>des</sub>	10	-	-	ns
DE hold time	t <sub>deh</sub>	10	-	-	ns
Vsync setup time	t <sub>vhs</sub>	10	-	-	ns
Vsync hold time	t <sub>vhh</sub>	10	-	-	ns

Note (1): For parallel interface, maximum clock frequency is 15MHz

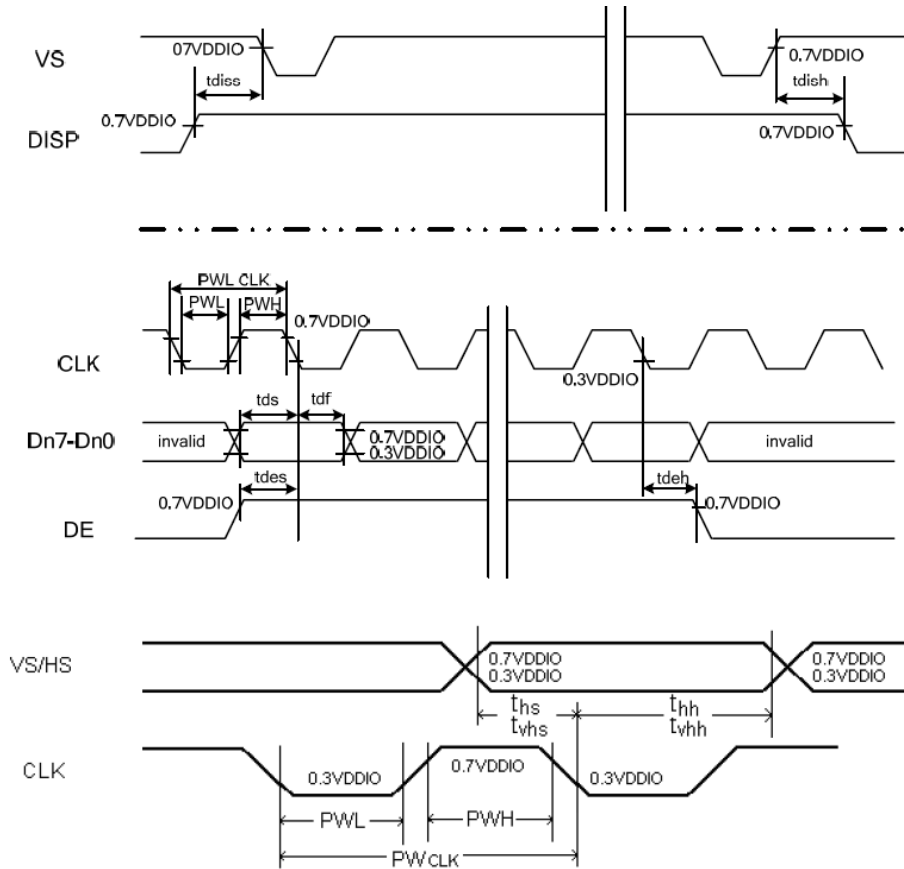

## Product Specification

	Model: GKCY43TNAH2E0	Rev. No.	Issued Date.	Page.
		A	2015,Jan,27	16 / 24

### 9.2 Parallel RGB Input Timing Table

Signal	Parameter	Symbol	Min.	Typ.	Max.	Unit.	Remark
CLK	DCLK frequency	fCLK	-	9	15	MHz	
Hsync	Hsync cycle	1/th	-	17.14	-	KHz	
	Horizontal cycle	th	525	525	605	CLK	
	Display Period	thd	480	480	480	CLK	
	Back Porch	thb	2	2	41	CLK	(2)
	Front Porch	thf	2	2	82	CLK	
	Pulse Width	Thp	2	41	41	DCLK	(2)
Vsync	Vsync cycle	1/tv	-	59.94	-	Hz	
	Vertical cycle	tv	285	286	399	H	(1)
	Display Period	tvd	272	272	272	H	(1)
	Back Porch	tvb	1	2	11	H	(1)
	Front Porch	tvf	1	2	227	H	(1)
	Pulse Width	tvp	1	10	11	H	(1)

Note (1): Unit: CLK=1/ fCLK , H= th,

Note (2): It is necessary to keep  $tvp+tvb=12$  and  $thp+thb=43$  in sync mode. DE mode is unnecessary to keep it.



# Product Specification



Model: GKCY43TNAH2E0

Rev. No.

Issued Date.

Page.

A

2015,Jan,27

17 / 24

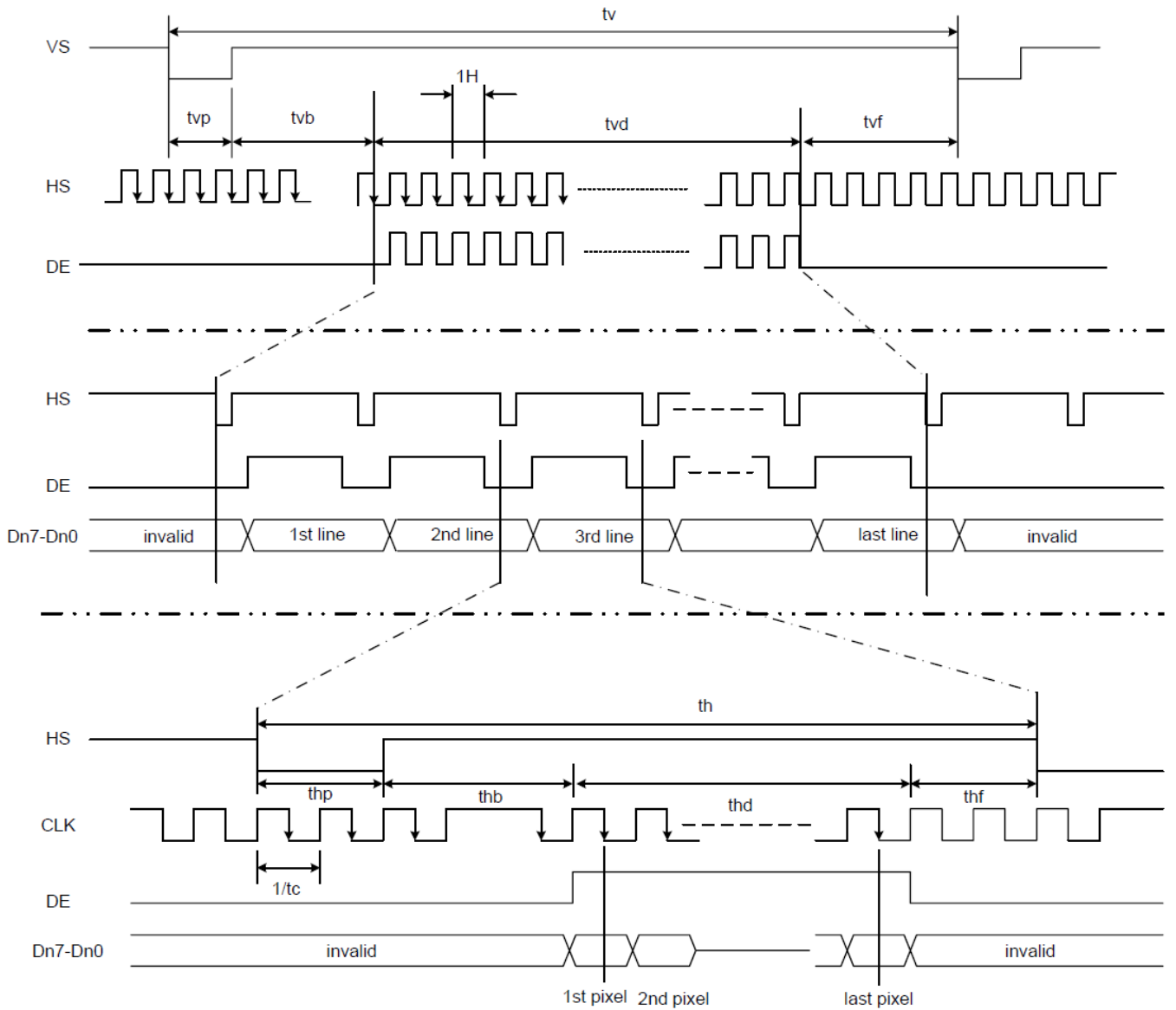

## Product Specification



Model: GKCY43TNAH2E0

Rev. No.

Issued Date.

Page.

A

2015,Jan,27

18 / 24

### 9.3 POWER ON/OFF SEQUENCE

#### 9.3.1 Power ON Sequence

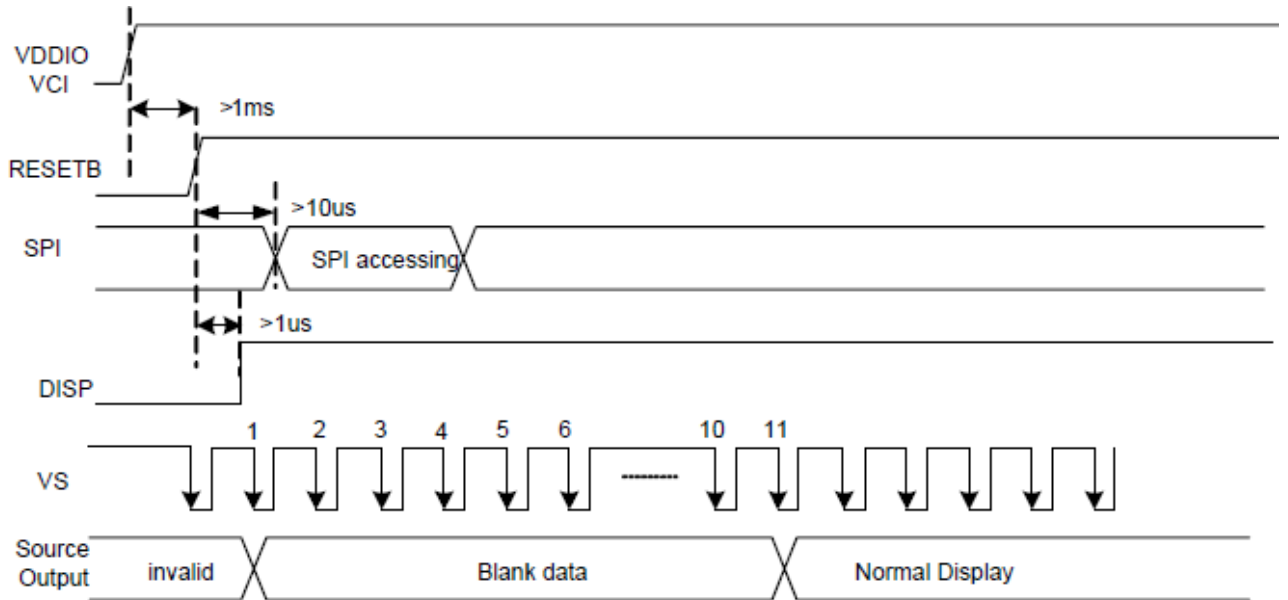

#### 9.3.2 Power OFF Sequence

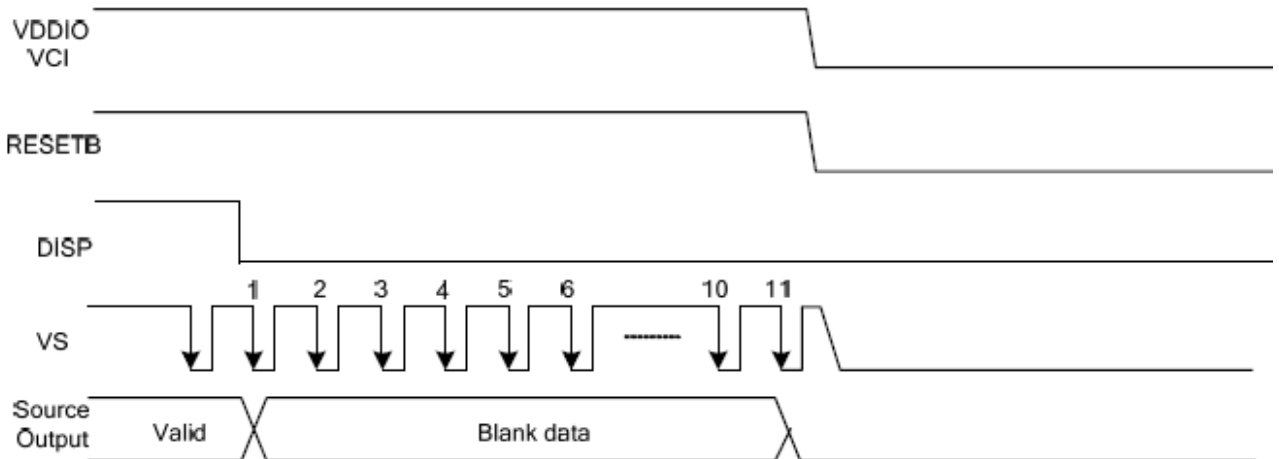

## Product Specification

	Model: GKCY43TNAH2E0	Rev. No.	Issued Date.	Page.
		A	2015,Jan,27	19 / 24

### 10 Test

No change on display and in operation under the following test condition.

Condition: Unless otherwise specified, tests will be conducted under the following condition.

Temperature: 20±5°C.

Humidity: 65±5%RH.

Tests will be not conducted under functioning state.

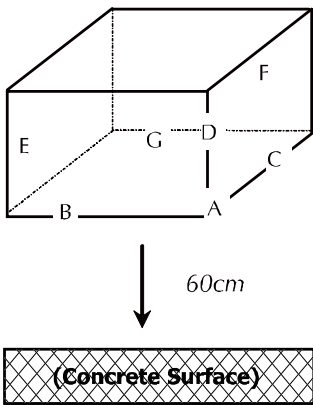
No.	Parameter	Condition	Notes
1	High Temperature Operating	85°C±2°C, 240hrs (Operation state).	
2	Low Temperature Operating	-30°C±2°C, 240hrs (Operation state).	1
3	High Temperature Storage	85°C±2°C, 240hrs.	2
4	Low Temperature Storage	-30°C±2°C, 240hrs.	1,2
5	High Temperature and High Humidity Operation Test	60°C±2°C, 90%, 240hrs	1,2
6	Vibration Test	Total fixed amplitude: 1.5mm. Vibration Frequency: 10~55Hz. One cycle 60 seconds to 3 direction of X, Y, Z each 15 minutes.	3
7	Electro Static Discharge Test (non-operating)	Panel Surface/Top Case: 150pF, 330 ohm Air: ±12kV, Contact: ±6kV	
8	Drop Test	To be measured after dropping from 60cm high on the concrete surface in packing state.   <p style="margin-left: 20px;"><i>Dropping method corner dropping:</i></p> <p style="margin-left: 20px;"><i>A corner: Once edge dropping.</i></p> <p style="margin-left: 20px;"><i>B, C, D edge: Once face dropping.</i></p> <p style="margin-left: 20px;"><i>E, F, G face: Once.</i></p>	

- Notes:
1. No dew condensation to be observed.
  2. The function test shall be conducted after 4 hours storage at the normal temperature and humidity after removed from the test chamber.
  3. Vibration test will be conducted to the product itself without putting I in a container.

# Product Specification



Model: GKCY43TNAH2E0

Rev. No.

Issued Date.

Page.

A

2015,Jan,27

20 / 24

## 11 Dimensional outlines

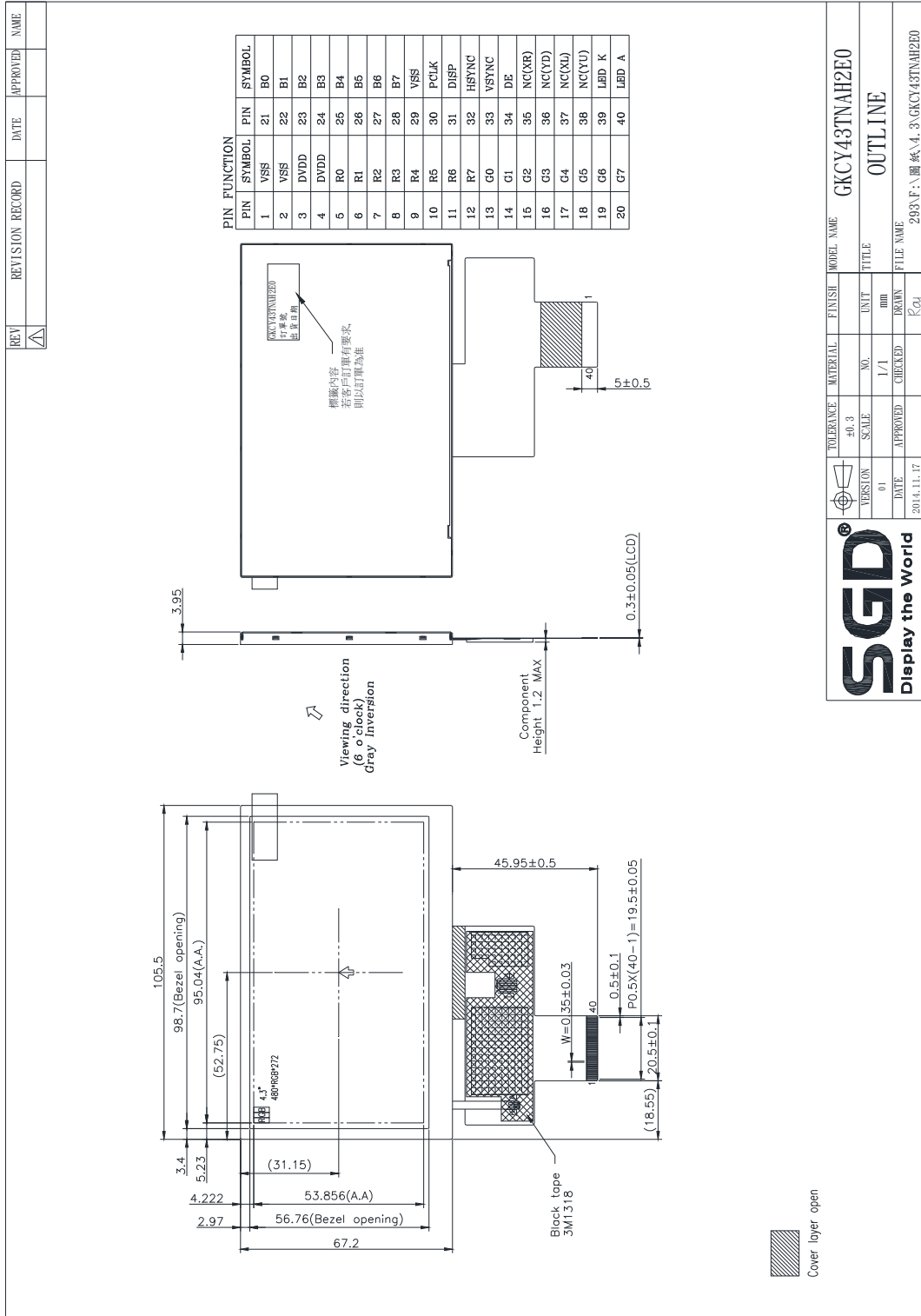

## Product Specification

	Model: GKCY43TNAH2E0	Rev. No.	Issued Date.	Page.
		A	2015,Jan,27	21 / 24

### 12 Incoming Inspection Standards

#### 12.1 Inspection and Environment Conditions

##### 12.1.1 Inspection Conditions:

- (1) Inspection Distance: 35 cm $\pm$ 5cm
- (2) View Angle : Light-on Inspection Angle :  $\pm 5^\circ$

Cosmetic Inspection Angle :  $\pm 45^\circ$

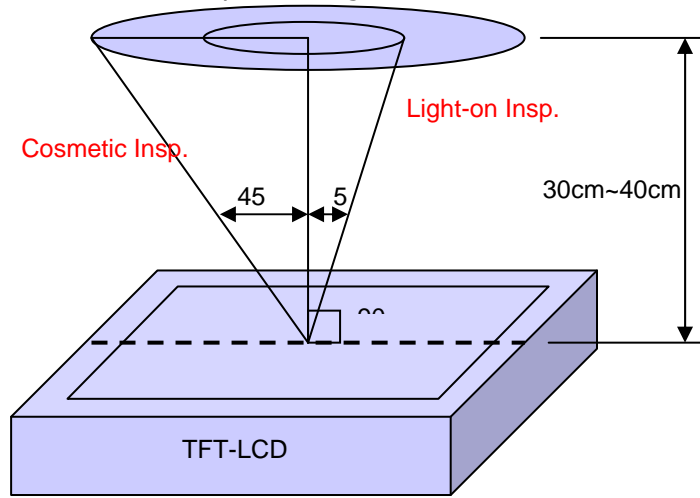

( perpendicular to LCD panel surface)

##### 12.1.2 Environment Conditions:

Ambient Temperature		23°C $\pm$ 5°C
Ambient Humidity		55 $\pm$ 10%RH
Ambient Illumination	Cosmetic Inspection	more than 600 Lux
	Functional Inspection	300~500 Lux

##### 12.1.3 Sampling Conditions:

- (1) Lot Size: Quantity of shipment lot per model
- (2) Sampling Method:

Sampling Plan		MIL-STD-105E
		Normal Inspection, Single Sampling Level II
AQL	Major Defect	1.0%
	Minor Defect	1.5%

- (3) The classification of Major(MA) and Minor(MI) defects is shown as 3. Inspection Criteria.

## Product Specification

	Model: GKCY43TNAH2E0	Rev. No.	Issued Date.	Page.
		A	2015,Jan,27	22 / 24

### 12.1.4 Inspection Criteria

#### 12.1.4.1 Cosmetic Inspection(Panel):

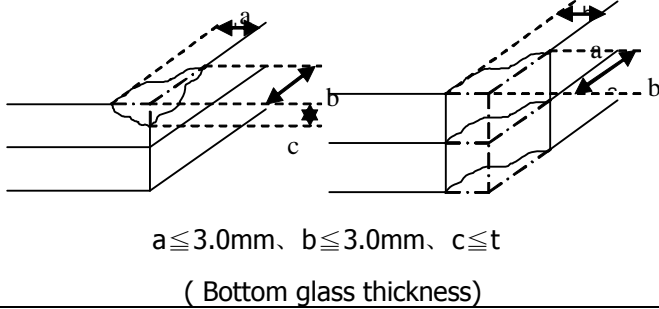
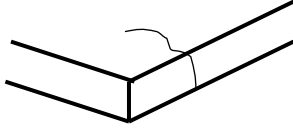
Item	Judgment Criteria	Classification
Chipping on Panel	 <p style="text-align: center;"><math>a \leq 3.0\text{mm}</math>, <math>b \leq 3.0\text{mm}</math>, <math>c \leq t</math> ( Bottom glass thickness)</p>	MA
Scratch on Panel *Note-2	$W \leq 0.05\text{mm}$ or $L < 5\text{mm}$ : Ignored $0.05\text{mm} < W \leq 0.1\text{mm}$ and $L \leq 5\text{mm}$ : $N \leq 5$ $W > 0.1\text{mm}$ or $L > 5\text{mm}$ : Not allowed	MI
Bubble or Dent on Panel *Note-3	$D \leq 0.2\text{mm}$ : Ignored $0.2\text{mm} < D \leq 0.3\text{mm}$ : $N \leq 5$ $D > 0.3\text{mm}$ : Not allowed	MI
Panel Crack	 <p style="text-align: center;">Not Allowed crack</p>	MA
Bezel Deformation	Obvious deformation is not allowed.	MI
Bezel Oxidation	Not allowed if it rusts continuously over 1 cm (It is out of warranty with rusted tin plate)	MI
Bezel Scratch	$L \leq 20\text{mm}$ , $W \leq 0.2$ , $N \leq 3$	MI
Metal Squash Dent /Flange(Front Side)	$D(W) \leq 1, L \leq 3, N \leq 3;$	MI
B/L High Voltage Wire Denudation	Not allowed	MA
Polarizer flaw or leak out resin	Defect is defined as the active area.	MI

## Product Specification

	Model: GKCY43TNAH2E0	Rev. No.	Issued Date.	Page.
		A	2015,Jan,27	23 / 24

Outline Dimension	Must in Spec, refer to related product spec.	MI
-------------------	--	----

### 12.1.4.2 Functional Inspection:

Item	Judgment Criteria			Classification
	Area(Note1)	I	O	
Point Defect	Bright dot	Random	2	
		2 dots adjacent	0	0
		3 dots adjacent or more	0	0
	Dark dot	Random	3	
		2 dots adjacent	0	
		3 dots adjacent or more	0	0
	Total Dot Defect		5	
	Distance	Distance between Bright and Bright dot	$L \geq 5\text{mm}$	
		Distance between Bright and Dark dot	$L \geq 5\text{mm}$	
		Distance between Dark dot	$L \geq 5\text{mm}$	
(1) It is defined as Point Defect if defect area > 0.5dot (2) It is ignored if defect area $\leq 0.5\text{dot}$ (3) Weak point defect will be defined as Bright Dot if it can be observed through ND filter 5%( Full Screen Black Inspection)				
Line Defect	Obvious vertical or horizontal line defect is not allowed.			MA
Mura	Not allowed if it can be observed through ND Filter 5 %			MI
Foreign Material in spot shape *Note-3	$D \leq 0.2\text{mm}$ : Ignored $0.2\text{mm} < D \leq 0.5\text{mm}$ : $N \leq 8$ $D > 0.5\text{mm}$ : Not allowed			MI
Foreign Material in line or spiral shape *Note-4	$W \leq 0.05\text{mm}$ or $L \leq 5\text{mm}$ : Ignored $0.05\text{mm} < W \leq 0.2\text{mm}$ and $L 1.0\text{mm} \leq 5\text{mm}$ : $N \leq 8$ $W > 0.2\text{mm}$ or $L > 5\text{mm}$ : Not allowed			MI
Display Function Abnormal	No Malfunction can be allowed			MA

## Product Specification

	Model: GKCY43TNAH2E0	Rev. No.	Issued Date.	Page.
		A	2015,Jan,27	24 / 24

Note-1 : I/O Area Definition

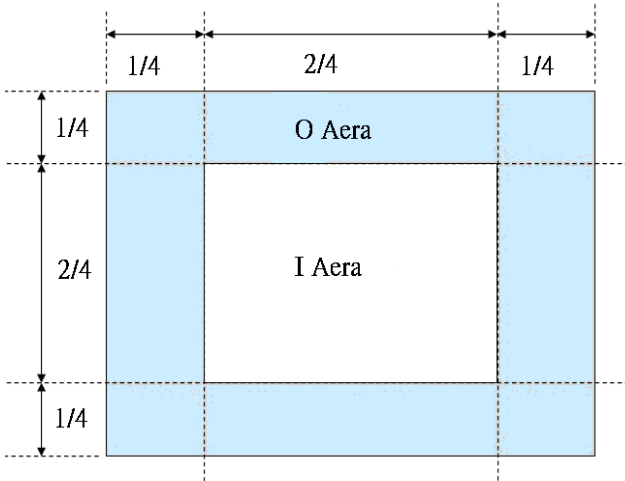

Note-2 : Polarizer Scratch

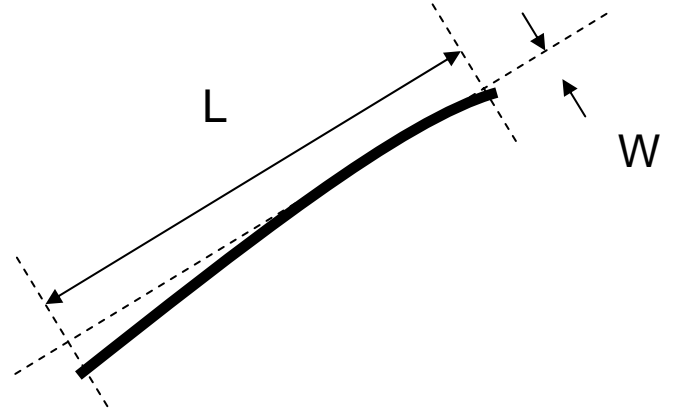

Note-3 : Spot Foreign Material  
( $W \geq L / 4$ )

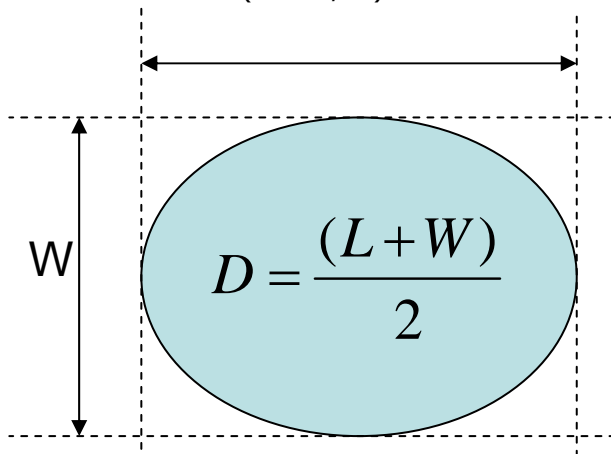

Note-4 : Line or Spiral Foreign Material  
( $W < L / 4$ )

