

## COBP High Speed Photo Diode

### ■ GENERAL DESCRIPTION

The NJL6401R-3 is a high-speed PIN photodiode capable of detecting in a wide wavelength range of up to infrared light from the blue-violet light.

The features are low wavelength dependence and fast fall-time.

An ultra-small and thin package of COBP is adopted, and providing high efficient space-saving.

### ■ FEATURES

- Corresponding to three wavelength ( $\lambda=405\text{nm}/650\text{nm}/780\text{nm}$ )
- Short rise-time, fall-time  
2ns typ. ( $\lambda=405\text{nm}/650\text{nm}/780\text{nm}$ ,  $V_R=2.5\text{V}$ , 10-90%)
- High speed  
250MHz ( $\lambda=780\text{nm}$ )  
300MHz ( $\lambda=650\text{nm}$ )  
350MHz ( $\lambda=405\text{nm}$ )
- Miniature, thin package    1.2mmX1.7mmX0.8mm
- Active area                    0.7mmX0.7mm

### ■ APPLICATIONS

- Laser monitor for Blu-ray, etc.
- Monitor for RGB wavelength
- Photoelectric switch, Space light transmitting, etc.

### ■ ABSOLUTE MAXIMUM RATINGS (Ta=25°C)

PARAMETER	SYMBOL	RATINGS	UNIT
Reverse Voltage	VR	35	V
Operating Temperature	Topr	-30 to +85	°C
Storage Temperature	Tstg	-40 to +100	°C
Reflow Soldering Temperature	Tsol	255	°C

### ■ ELECTRO-OPTICAL CHARACTERISTICS (Ta=25°C)

PARAMETER	SYMBOL	TEST CONDITION	MIN	TYP	MAX	UNIT
Dark Current	ID	VR=10V	—	0.1	2.0	nA
Forward Voltage	VF	IF=1mA	—	—	1.0	V
Capacitance	Ct	VR=2.5V, f=1MHz	—	4	—	pF
Peak Wavelength	$\lambda_P$	—	—	800	—	nm
Sensitivity	S	VR=2.5V, $\lambda=780\text{nm}$	0.37	0.47	—	AW
		VR=2.5V, $\lambda=650\text{nm}$	0.34	0.42	—	AW
		VR=2.5V, $\lambda=405\text{nm}$	0.22	0.28	—	AW
Rise time, Fall time	tr/ff	VR=2.5V, $\lambda=780\text{nm}$ , 10-90%, 1mW	—	2	—	ns
		VR=2.5V, $\lambda=650\text{nm}$ , 10-90%, 1mW	—	2	—	ns
		VR=2.5V, $\lambda=405\text{nm}$ , 10-90%, 1mW	—	2	—	ns
Cut off Frequency	fc	VR=2.5V, $\lambda=780\text{nm}$ , RL=50Ω, -3dB	—	250	—	MHz
		VR=2.5V, $\lambda=650\text{nm}$ , RL=50Ω, -3dB	—	300	—	MHz
		VR=2.5V, $\lambda=405\text{nm}$ , RL=50Ω, -3dB	—	350	—	MHz

■ OUTLINE Unit : mm

Active area: 0.7x0.7mm

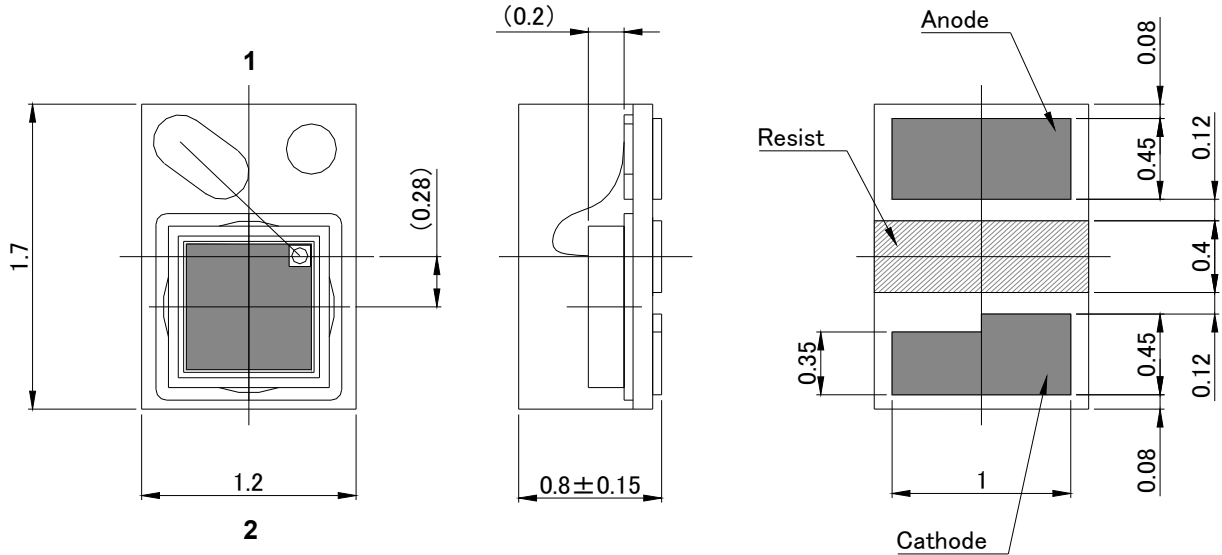

1: anode  
2: cathode

GENERAL TOLERANCE : ± 0.1mm

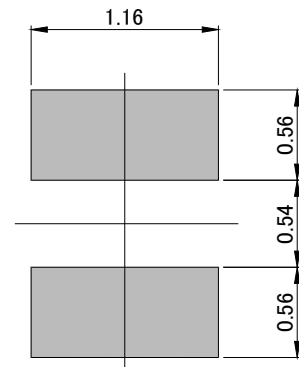

PCB Pattern

## ■ TYPICAL CHARACTERISTICS

Relative Sensitivity vs. Illuminance (Ta=25°C)

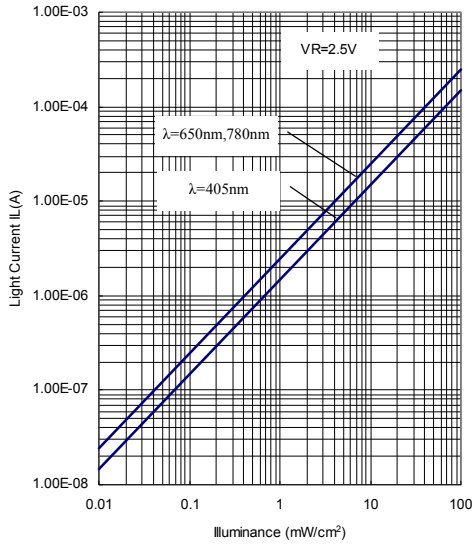

Spectral Response (Ta=25°C)

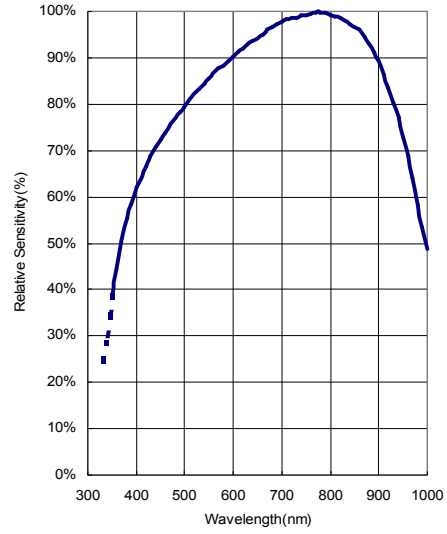

Dark Current vs. Temperature

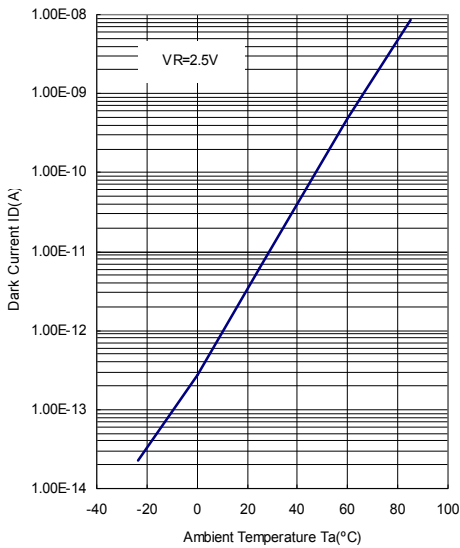

Relative Sensitivity vs. Temperature

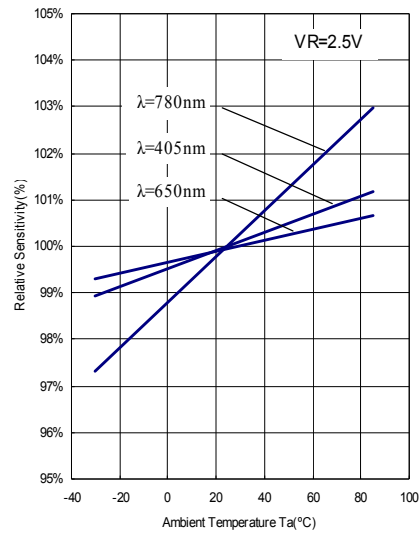

Rise Time vs. Reverse Voltage (Ta=25°C)

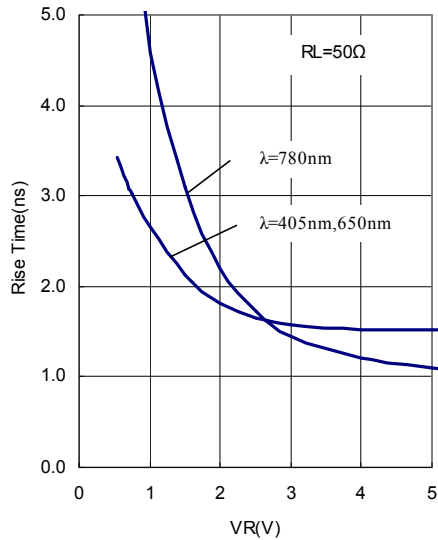

Fall Time vs. Reverse Voltage (Ta=25°C)

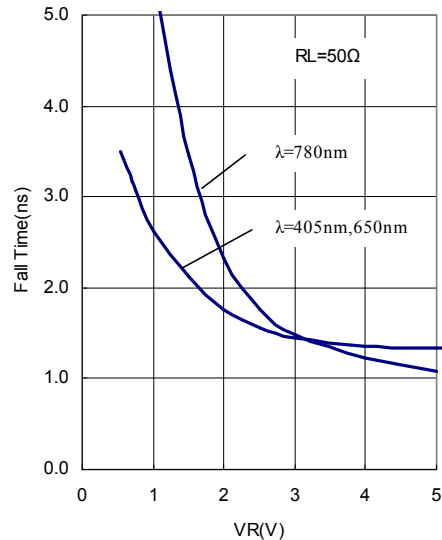

Relative Sensitivity vs. Frequency (Ta=25°C)

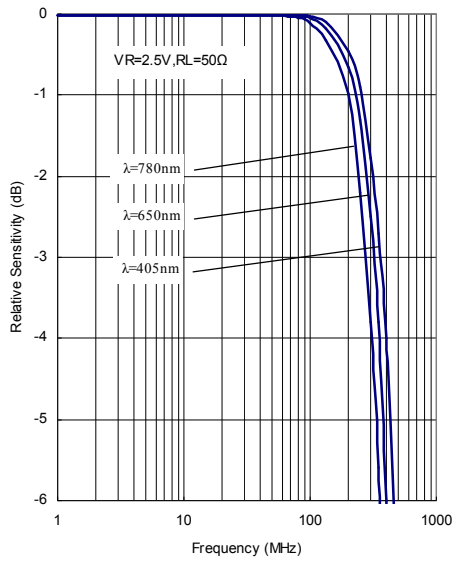

Capacitance vs. Reverse Voltage (Ta=25°C)

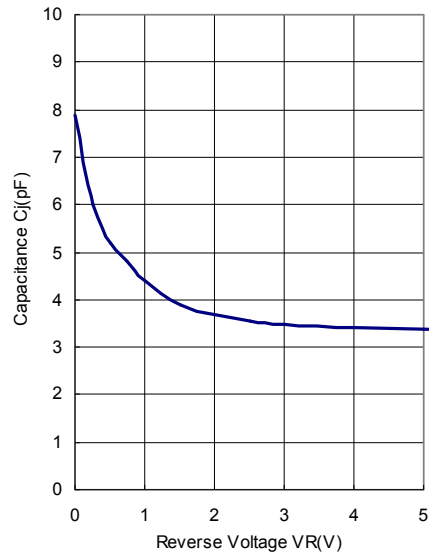

■ MEASURING CIRCUIT FOR RESPONSE TIME

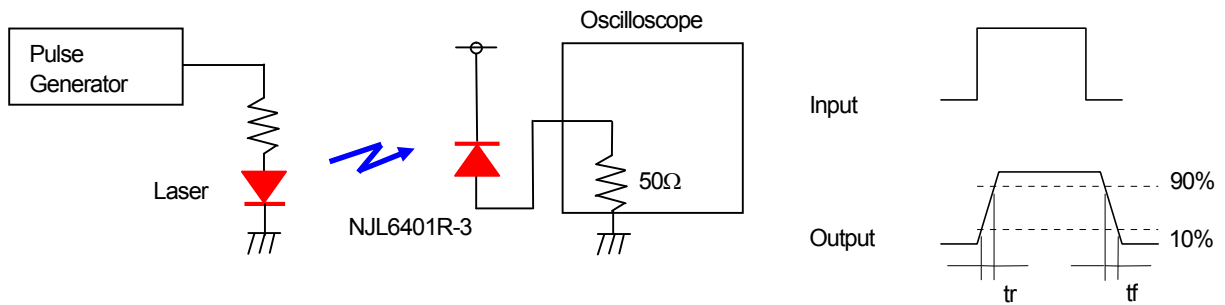

## ■ MOUNTING METHOD

### NOTE

Mounting was evaluated with the following profiles in our company, so there was no problem.  
However, confirm mounting by the condition of your company beforehand.

The exposure of device under higher temperature many affect to the reliability of the products, it is recommended to complete soldering in the shortest time possible.

Mounting: Twice soldering is allowed.

## ■ INFRARED REFLOW SOLDERING METHOD

### Recommended reflow soldering procedure

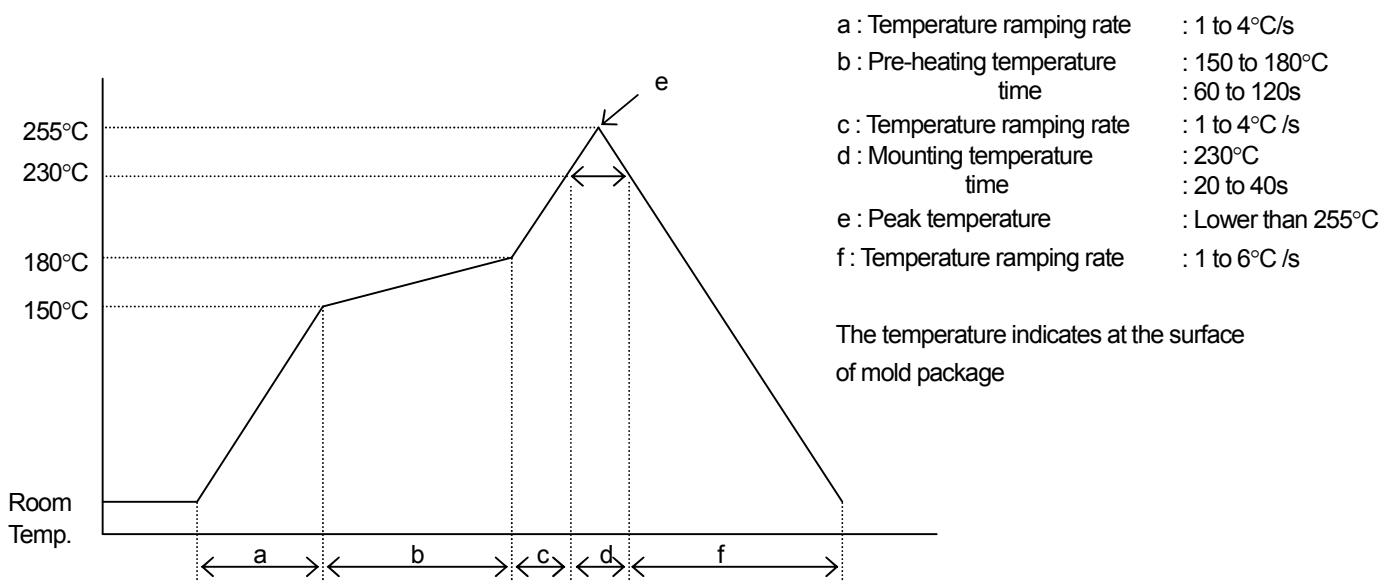

(NOTE1) Using reflow furnace with short wave infrared radiation heater such as halogen lamp

Regarding temperature profile, please refer to those fo reflow furnace.

In this case the resin surface temperature may become higher than lead terminals due to endothermic ally of black colored mold resin. Therefore, please avoid from direct exposure to mold resin.

(NOTE2) Other method

Such other methods of soldering as dipping the device into melted solder and vapor phase method (VPS) are not appropriate because the body of device will be heated rapidly. Therefore, these are not recommended to apply.

(NOTE3) The resin gets softened right after soldering, so, the following care has to be taken

Not to contact the lens surface to anything.

Not to dip the device into water or any solvents.

## ■ FLOE SOLDERING METHOD

Flow soldering is not possible.

## ■ IRON SOLDERING METHOD

Iron soldering is not possible.

## ■ CLEANING

When Cleaning is needed the following conditions are recommended as the ultrasonic cleaning:

Solvent : isopropyl alcohol

Frequency: 40kHz

Power: 30W/ ℓ

Temperature: Lower than 50°C

Time: Shorter than 300s

Cleaning: Once

(NOTE1) Do not resonate the products.

(NOTE2) Do not touch the products or their mounted board directly to the vibrator.

(NOTE3) Do not clean the product immediately after the reflow.

(NOTE4) Avoid the solvent or the vapor solvent from the resin of the device even during the mounting and using.

## ■ IC STORAGE CONDITIONS AND ITS DURATION

(1) Temperature and humidity ranges

Pack Sealing	Temperature:	5 to 40 [°C]
	Humidity:	40 to 80 [%]
Pack Opening	Temperature:	5 to 30 [°C]
	Humidity:	40 to 70 [%]

After opening the bag, solder products within 48 hours.

Avoid a dry environment below 40% because the products are easily damageable by the electrical discharge.

Store the products in the place where it does not create dew with the products due to a sudden change in temperature.

(2) When baking, place the reel vertically to avoid load to the side.

(3) Do not store the devices in corrosive-gas atmosphere.

(4) Do not store the devices in a dusty place.

(5) Do not expose the devices to direct rays of the sun.

(6) Do not allow external forces or loads to be applied to IC's.

(7) Be careful because affixed label on the reel might be peeled off when baking.

(8) The product is recommended to do the baking before using for the stability of the quality.

## ■ BAKING

In case of keeping expect above condition be sure to apply baking. (Heat-resistant tape)

Baking method: Ta=60°C, 48 to 72h, Three times baking is allowed

Ta=100°C, 2 to 6h, Three times baking is allowed

## ■ STORAGE DURATION

Within a year after delivering this device.

For the products stored longer than a year, confirm their terminals and solderability before they are used.

## ■ APPLICATION NOTES

When using the laser diode in the vicinity of  $\lambda=405\text{nm}$ , there is the restriction in terms of use.

Please be careful in the case of the use.

■ PACKING SPECIFICATION

PACKING DIMENTIONS UNIT : mm

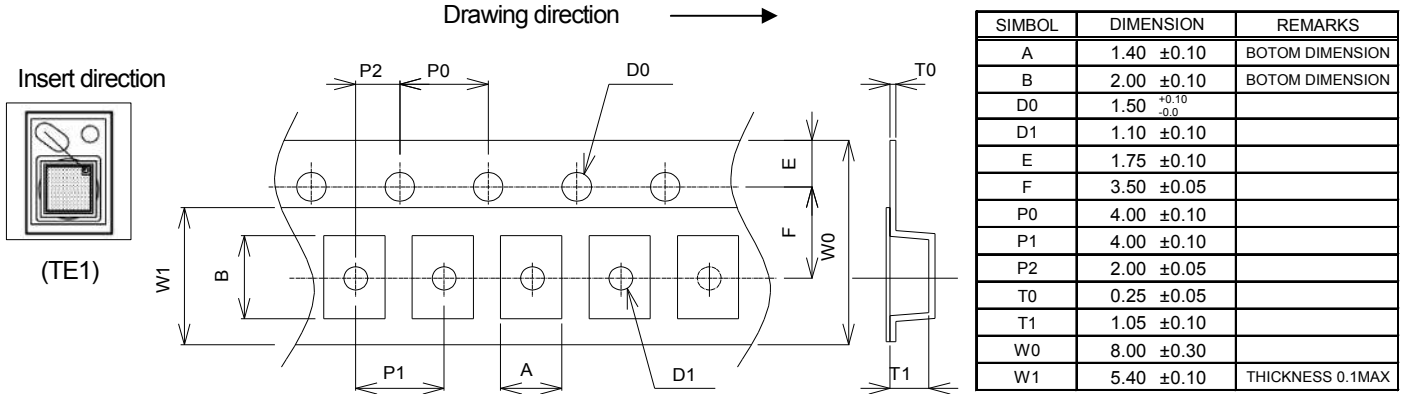

\* Carrier tape material : Polycarbonate(antistatic)  
Cover tape material : Polyester(antistatic)

■ Taping Strength

Pull up the cover tape from the carrier tape, and when the opening angle comes around 10 to 15 , and the peeling-off strength is to be within the power of 20 to 40g.

■ Packaging

- 1) The taped products are to be rolled up on the taping reel as on the drawing.
- 2) Rolling up specification
  - 2-1) Start rolling : Carrier tape open space more than 20 Pieces.
  - 2-2) End of rolling : Carrier tape open space more than 20 Pieces, and 2 round of reel space at the cover tape only.
- 3) Taping quantity : 2,000 Pieces
- 4) Seal off after putting each reels in a damp proof bag with silica gel.

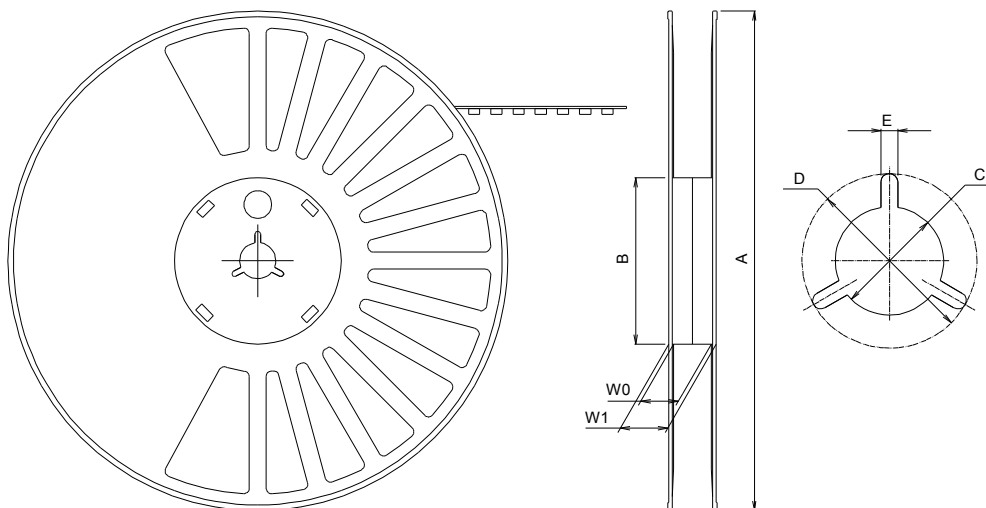

\* Reel material : PPE(antistatic)

[CAUTION]  
The specifications on this databook are only given for information , without any guarantee as regards either mistakes or omissions. The application circuits in this databook are described only to show representative usages of the product and not intended for the guarantee or permission of any right including the industrial rights.