

# endrich news

www.endrich.com

## Our Product of the Month RAYSTAR Standard TFT-Displays/Q-Series

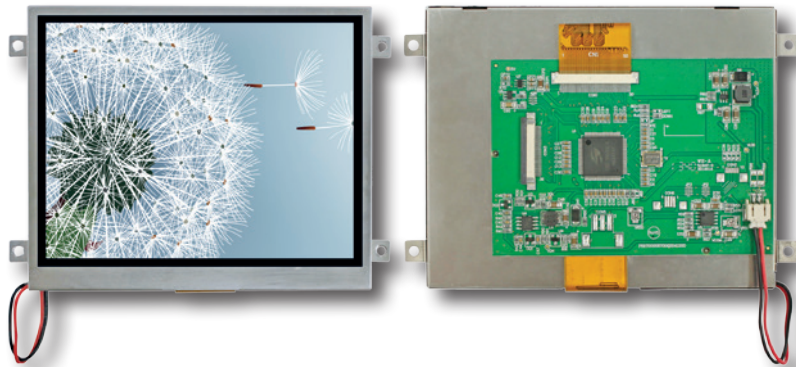

- Sizes: 3.5" up to 10.2"
- Unified 36-pin standard MCU interface
- Implemented display controller SSD1963
- Optional 8 bit/16 bit control
- Integrated LED backlight driver
- Optional with resistive or capacitive touch panel



Innovative Standard Displays

# FAN FOR USE IN GROUND CONVEYOR



## FEATURES

- » 24V<sub>DC</sub> axial fan motor
- » Mechanical size: 92 × 92 × 38 mm<sup>3</sup>
- » Double shielded double ball bearing
- » PWM speed control input
- » Lifetime expectancy L10 = 70.000 h @ 40°C
- » IP55 in accordance to IEC 60529
- » Operating temperature range: -40°C ... +70°C at 45% ... 85% rel. humidity
- » Cold start-up at -40°C
- » Storage temperature range: -40°C ... +85°C

ADDA: AD0924HB

## RELIABILITY TEST DATA

- » Shock
  - DIN EN 60068-2-29
  - Continuous shock
  - Shape: half-sinus
  - Acceleration: 25g
  - Duration: 6ms
  - Shock axis: ±X; ±Y; ±Z
  - Number of shocks: 3.000 shocks per direction and axis
- » Vibration
  - DIN EN 60068-2-6
  - Shape: full-sinus
  - Acceleration: 30m/s<sup>2</sup>
  - Frequency, sweeping: 10 ... 500Hz
  - Sweeping rate: 1 Octave / min.
  - Duration: 2h per axis
  - Vibration axis: X; Y; Z
- » EMC / EMI
  - EN 12895:2000 and DIN prEN 12895:2013 (DRAFT)
  - No abnormal behaviour found when built-in and operated in the vehicle
- » Further standards and regulations:
  - EN 60950
  - UL 507
  - EN 61000-6-1
  - EN 61000-6-3

## AIR PERFORMANCE CURVE (p-q'-CURVE)

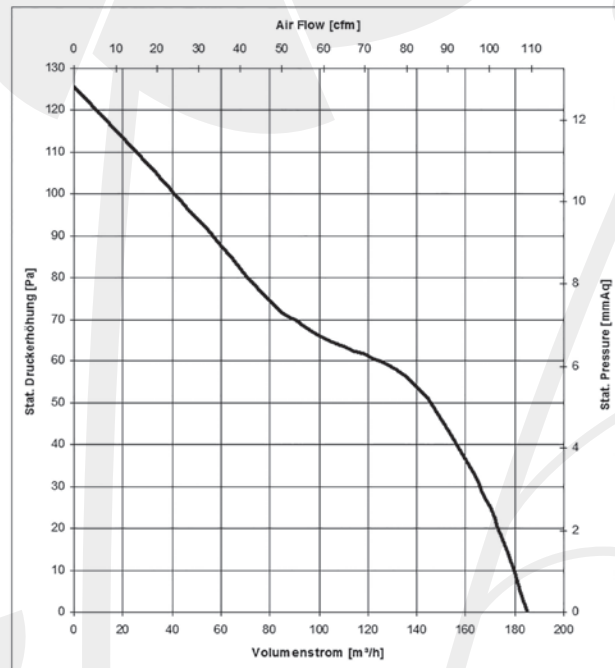

Other fans available on request!

Reserve technical changes!

# TFT-DISPLAYS / Q-SERIES



PIN	All function
1	GND
2	VDD (3V)
3	BL_E
4	RS
5	WR
6	RD
7 ~ 22	DB0 ~ DB15
23	NC / TE
24	NC/ For CTP
25	CS
26	RESET
27	NC(UD)
28	NC(LR)
29 ~ 32	For TP function CTP & RTP
33-34	B/L power (Gnd)
35-36	B/L power (VCC)

The Q-series of **RAYSTAR Optonics** has a uniform 36-pin standard MCU interface. All modules have a back board with integrated controller SSD1963, which can be driven by 8 or 16 bit. Due to the unified interface it is not necessary to change the board layout if there is a display resizing within the Q-series.

### ADVANTAGES OF Q-SERIES

- » Unified standard MCU interface
- » Implemented display controller SSD1963
- » Optional 8 bit / 16 bit control
- » Integrated LED backlight driver
- » Optional with resistive or capacitive touch panel

SIZE	MODEL NUMBER	DISPLAY RESOLUTION	BRIGHTNESS [cd/m <sup>2</sup> ]	TYP. BACKLIGHT LIFE TIME [h]	INTERFACE 16 BIT MCU	OPERATING TEMPERATURE [°C]	RESISTIVE TOUCH PANEL	CAPACITIVE TOUCH PANEL (PCAP)
<b>Q-SERIES</b>								
3.5"	RFC350Q-EIW-DBN	320×240	420	50 k	•	-20...+70		
3.5"	RFC350Q-EIW-DBS	320×240	300	50 k	•	-20...+70	•	
3.5"	RFC350Q-EIW-DBC	320×240	340	50 k	•	-20...+70		•
4.3"	RFC430Q-EIW-DBN	480×272	500	50 k	•	-20...+70		
4.3"	RFC430Q-EIW-DBS	480×272	300	50 k	•	-20...+70	•	
4.3"	RFC430Q-EIW-DBC	480×272	340	50 k	•	-20...+70		•
5.0"	RFC50YQ-1IW-DBN	800×480	450	20 k	•	-20...+70		
5.0"	RFC50YQ-1IW-DBS	800×480	300	20 k	•	-20...+70	•	
5.7"	RFC570Q-EIW-DBN	320×240	500	50 k	•	-20...+70		
5.7"	RFC570Q-EIW-DBS	320×240	350	50 k	•	-20...+70	•	
5.7"	RFC570Q-EIW-DBG	320×240	400	50 k	•	-20...+70		•
7.0"	RFC700Q-1IW-DBN	800×480	450	50 k	•	-20...+70		
7.0"	RFC700Q-1IW-DBS	800×480	300	50 k	•	-20...+70	•	
7.0"	RFC700Q-1IW-DBG	800×480	380	50 k	•	-20...+70		•
8.0"	RFC800Q-1IW-DBN	800×480	450	20 k	•	-20...+70		
8.0"	RFC800Q-1IW-DBS	800×480	320	20 k	•	-20...+70	•	
8.0"	RFC800Q-1IW-DBC	800×480	360	20 k	•	-20...+70		•
10.2"	RFC1020Q-1IW-DBN	800×480	350	20 k	•	-20...+70		
10.2"	RFC1020Q-1IW-DBS	800×480	250	20 k	•	-20...+70	•	
10.2"	RFC1020Q-1IW-DBG	800×480	280	20 k	•	-20...+70		•

Reserve technical changes!

# NEW REVERSIBLE USB-CONNECTOR, UP TO 100 W

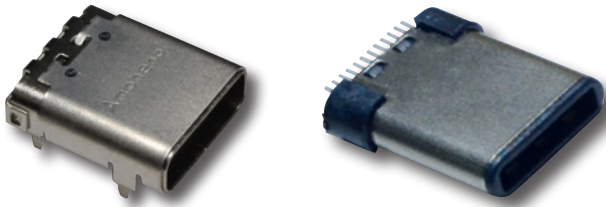

**The new USB connector is rotatable and reversible, delivers up to 100 watts and is smaller, faster and more stable than ever.**

## PIN ASSIGNMENT FOR REVERSIBLE USB-TYPE-C

Pin	Signal Name	Description	Mating Sequence	Pin	Signal Name	Description	Mating Sequence
A1	GND	Ground return	First	B12	GND	Ground return	First
A2	SSTXp1	Positive half of first SuperSpeed TX differential pair	Second	B11	SSRXp1	Positive half of first SuperSpeed RX differential pair	Second
A3	SSTXn1	Negative half of first SuperSpeed TX differential pair	Second	B10	SSRXn1	Negative half of first SuperSpeed RX differential pair	Second
A4	VBUS	Bus Power	First	B9	VBUS	Bus Power	First
A5	CC1	Configuration Channel	Second	B8	SBU2	Sideband Use (SBU)	Second
A6	Dp1	Positive half of the USB 2.0 differential pair - Position 1	Second	B7	Dn2	Negative half of the USB 2.0 differential pair - Position 2	Second
A7	Dn1	Negative half of the USB 2.0 differential pair - Position 1	Second	B6	Dp2	Positive half of the USB 2.0 differential pair - Position 2	Second
A8	SBU1	Sideband Use (SBU)	Second	B5	CC2	Configuration Channel	Second
A9	VBUS	Bus Power	First	B4	VBUS	Bus Power	First
A10	SSRXn2	Negative half of second SuperSpeed RX differential pair	Second	B3	SSTXn2	Negative half of second SuperSpeed TX differential pair	Second
A11	SSRXp2	Positive half of second SuperSpeed RX differential pair	Second	B2	SSTXp2	Positive half of second SuperSpeed TX differential pair	Second
A12	GND	Ground return	First	B1	GND	Ground return	First

## USB-TYP-C KEY ASPECTS

- » Entirely new design - tailored for emerging product designs
- » New smaller size - similar to size of USB2.0 Micro-B
- » Usability enhancements - reversible plug orientation & cable direction
- » Rugged construction with up to 10,000 plug cycles
- » Powerful with up to 100 watts
- » Speed doubling compared to 3.0 to 10Gbit/s

## USB-TYPE-C CABLE AND PLUG MODELS

USB Type-C Cable and Connector Renderings  
 Provided by the USB 3.0 Promoter Group

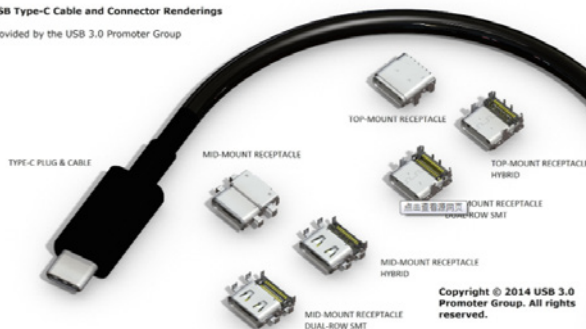

A special feature of the new **USB Type-C** is its reversibility, i. e. it can be plugged in both directions. The USB Type-C allows for devices a power consumption of up to 100 watts. The flexibility of the new connector allows to realize different standards on the multiple occupancy.

What the new standard also distinguishes is its over previous USB connectors small size similar to that of USB2.0 Micro-B. Therefore, it is also on devices such as smartphones and tablets of the next generation space.

In addition, USB 3.1 doubles the transfer rate of 5 Gb/s (USB 3.0) to 10Gbit/s, but remains backward compatible with its predecessors.

## APPLICATIONS

- » Smart phone
- » Tablet
- » Mobile device
- » Ultra notebook



## BENEFIT - CHARGE CURRENT

With a USB Type-C connector to devices with a power up to 100 W they can be operated without additional power supply, e. g. as monitors, inkjet printer and powered speakers. Various profiles define the possible current levels (up to 5 A) and possible voltages (up to 20V). In addition to the usual voltage of 5V, 12V or 20V are also possible.  $V_{bus}$  is when connecting a device 5V and can be increased by means of negotiations of the serial protocol to  $V_{bus}$  of 12V or 20V. Another fundamental change is the release of the flow direction of the power supply. A computer can a monitor with electricity just like a monitor can provide a computer with power.

## POWER PROFILE

Profil	+5 V	+12 V	+20 V
1	2 A	-	-
2		1,5 A	
3		3,0 A	
4		3,0 A	
5		5,0 A	



## EON AND ESMT GO TOGETHER IN THE FUTURE

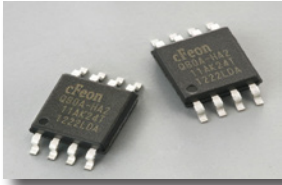

Announcement of the acquisition of EON by ESMT. The products of EON will continue be available and be supplied by Endrich.



### ***Eon Silicon Solution Inc.***

6F-2, No.30, Tai-Yuan Street, Chu-Pei,  
Hsin-Chu, Taiwan  
TEL:886-3-5525686 FAX:886-3-5525696

15<sup>th</sup> January, 2016

Subject : Notice of Merger--- Eon Silicon Solution Inc. and Elite  
Semiconductor Memory Technology Inc.

Dear Value Customers,

This is to inform you that Eon Silicon Solution Inc. (Eon) has resolved at its Shareholders Meeting held on December 28, 2015 to merge with Elite Semiconductor Memory Technology Inc. (ESMT), a corporation duly organized and existing under the laws of the Republic of China. The combined company will go forward together under the name of ESMT which will generally assume all Eon's assets and liabilities.

ESMT will continue supply Eon's NOR Flash products with Eon's logo and part numbers. As usual, we will continue our supports, and together with ESMT's broader product portfolio, to further satisfy your requirements.

We will keep you updated during the integration. If you have any questions, please feel free to contact our sales team.

Sincerely Yours,

C. H. Ho / Chairman  
Eon Silicon Solution Inc.

## FLAT PIEZO CERAMIC SOUNDERS – SERIES CSPT09A03 (9×9×1.8 mm<sup>3</sup>)



### DIMENSIONS (mm)

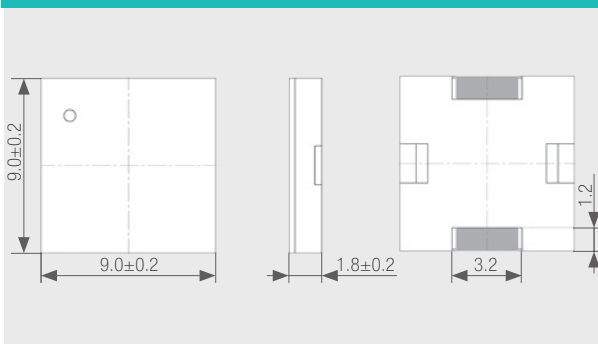

### FREQUENCY CHARACTERISTICS

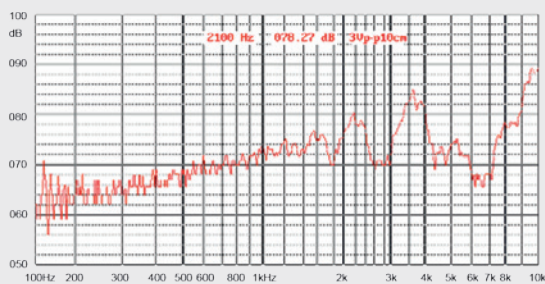

CSPT09A03-2.1F

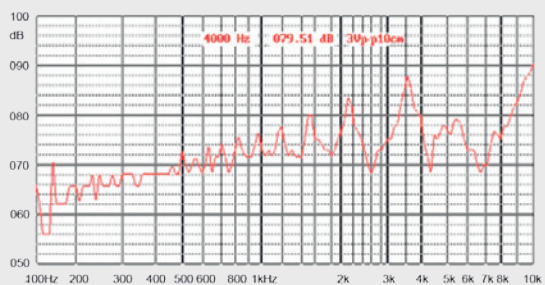

CSPT09A03-4.0F

From our manufacturer Changzhou Chinasound we have in our programme the innovative product series SMD-Piezo-Sounder (Transducer) with the housing dimensions 9 mm×9 mm×1.8 mm. There are two different types, each optimized for the reproduction of specific sound frequencies: one for nominal 4.0 kHz and one for 2.1 kHz.

At this point in time, these sound components series represents the smallest size available for piezoceramic sound components. The corresponding related part numbers are: CSPT09A03-4.0F and CSPT09A03-2.1F.

The frequency response curves provided by the manufacturer prove a good ability also for the reproduction of different frequencies, where still a well-noticeable sound will be generated by these components. Details are shown in the product data sheets.

In practical, these new 9×9 mm piezo transducers are generating sound pressure values, that are at least equal to the well-known and established 12×12 mm size components.

The current consumption is maximum 1mA, when driving the component at rated voltage (3V<sub>p-p</sub>). These components are fully reflowable according to JEDEC standard J-STD-020D.

We strongly suppose that these component series is highly interesting for all customers who care on miniaturization of all components to a maximum extent.

### FEATURES/TECHNICAL DATA

- » Currently, the smallest available piezo sounder
- » High reliability
- » Corrosion-resistant membrane
- » Flame-retardant housing
- » Lead free reflow solderable
- » Operating voltage: 20V<sub>D-P</sub> max.
- » Resonant frequency: 4000 Hz±500 Hz  
2100 Hz±500 Hz
- » Sound pressure level: 75 dB min. (@ 3V<sub>p-p</sub>, 10 cm, resonant frequency)
- » Current consumption: 1 mA max. (@ 3V<sub>p-p</sub>)
- » Capacitance: 15000 pF ±30% (@ 100Hz, 1V<sub>rms</sub>)
- » Operating temperature: -40 °C ... +105 °C
- » Storage temperature: -40 °C ... +120 °C
- » Packaging: Taped on reel

# WINDOWED WATCHDOG TIMER – MP64117MPQ6411

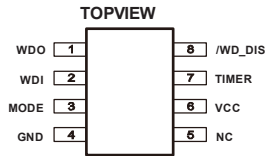
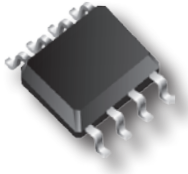

The **MP6411** is a windowed watchdog timer. It is used to reset and monitor the microcontroller. In normal operation, the MCU sends a trigger signal to the MP6411 in a defined time window cyclically. A missing or fault trigger signal causes the watchdog to reset the MCU. The MP6411 provides a reset signal (low-level voltage) to the MCU during power-up or under-voltage. By setting MODE to high or low, the watchdog operates in long window mode or short window mode; the window is programmable. The MP6411 is available in SOIC8 package.

## TECHNICAL PARAMETERS

- » Max. voltage (all pins): -0.3V ... +6V
- » Continuous power dissipation (Ta=25°C): 1.3W
- » Recommended supply voltage (VIN): 5V
- » Operating junction temperature: -40°C ... +125°C
- » Thermal resistance (SOIC8):  $\theta_{JA}=96^{\circ}\text{C/W}$   
 $\theta_{JC}=45^{\circ}\text{C/W}$

## APPLICATIONS

- » Auto infotainment
- » Industrial control systems

## FEATURES

- » Windowed Watchdog can work in long-window or short-window mode
- » Power-On Reset during Power-Up and Under-Voltage
- » Programmable short window mode or long window mode
- » Watchdog Disable Function
- » The MPQ6411 (industrial grade) can pass higher test temperatures than the MP6411.
- » SOIC8 package
- » All MPS parts are lead-free, halogen-free, and adhere to the RoHS directive

## BLOCK DIAGRAM

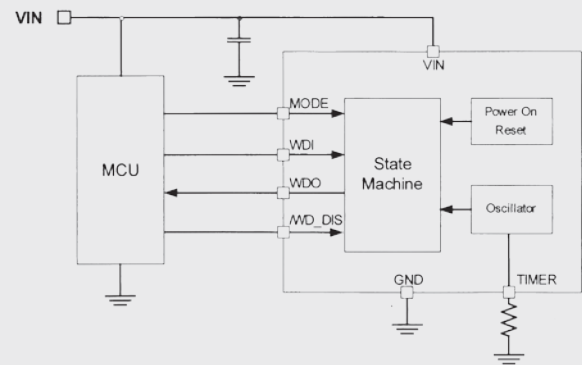

## MAIN BENEFIT

For standard watchdog, the microcontroller could become trapped in a routine of only emitting pulses. It is not capable of detecting potential program errors and would interpret this signal as valid.

Window watchdog offers higher system security by monitoring the minimum pulse period and the maximum pulse period. A watchdog pulse must occur within a certain window or time slot. Otherwise, the window watchdog resets the microcontroller.

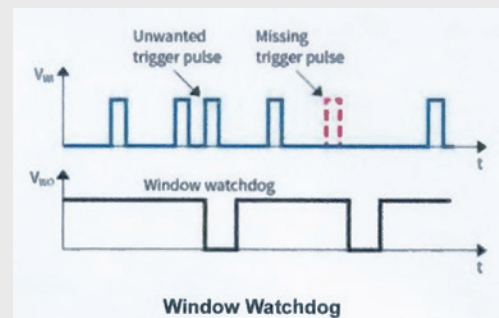
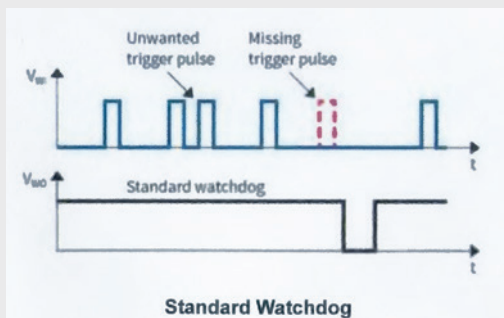

# FUTURE-PROOF QS TYPE INDUCTORS – UPDATE



## COMPARISON TO OTHER POPULAR TYPES

Series	QS3818	SH3018	DH3018
Value	100µH	100µH	100µH
DCR (Ω)	1,48	1,93	2.4
Isat (A)	0.20	0.18	0.20

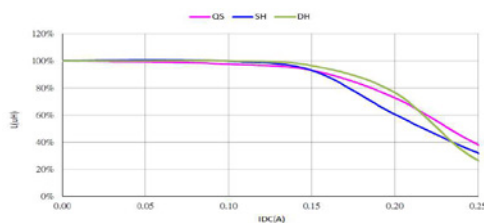

The **QS-Serie** of ABC is a new development of shielded SMD POWER inductors medium size ist eine Neuentwicklung von geschirmten SMD-POWER-Induktivitäten mittlerer Größe (4×4 mm ~ 5×5 mm, later to 7×7 mm).

The design for automated production and special design with positioning studs help to increase the production yield and to reduce manufacturing costs. By using PVD instead of the usual galvanizing the QS-type is produced in an environmentally friendly and energy-saving way.

The electrical characteristics are substantially similar to those already introduced, popular designs, but the DCR was significantly improved.

Using the example of 100 µH coil by up to 38 %.

Since January 2016 all types of QS series receive a marking (line) to identify the winding start as an additional feature.

SIZE	TYPE	DIMENSIONS [mm]	INDUCTANCE RANGE	RDC [mΩ]	I <sub>SAT</sub> [A]	I <sub>RMS</sub> [A]
4×4×2	QS3818-L	3.8±0.2×3.8±0.2×1.8±0.2	1 µH ... 100 µH	27.5 ... 2040	0.2 ... 2.1	0.34 ... 3.6
5×5×2	QS4818-L	4.8±0.2×4.8±0.2×1.8±0.2	1 µH ... 100 µH	19.2 ... 1158.4	0.33 ... 3.6	0.50 ... 5.1
5×5×3	QS4828-L	4.8±0.2×4.8±0.2×2.8±0.2	1.2 µH ... 560 µH	18.5 ... 2605.5	0.15 ... 3.0	0.30 ... 5.0
6×6×3	QS5828-L	5.8±0.2×5.8±0.2×2.8±0.2				
7×7×3	QS6828-L	6.8±0.2×6.8±0.2×2.8±0.2				

under development

Detailed datasheets incl. inductance change and temp. rise curves are available on [www.endrich.com](http://www.endrich.com)

Contact for information: Mr. Jung · Tel. +49(0)7452-6007- 26 · e-mail: [t.jung@endrich.com](mailto:t.jung@endrich.com)

## HEADQUARTERS

ENDRICH Bauelemente Vertriebs GmbH · P.O.Box 1251 · D-72192 Nagold  
 T +49 (0) 7452 6007-0 · F +49 (0) 7452 6007-70  
[endrich@endrich.com](mailto:endrich@endrich.com) · [www.endrich.com](http://www.endrich.com)



## SALES OFFICES IN EUROPE

France:  
 Paris: T +33/2 41 80 19 87 · [france@endrich.com](mailto:france@endrich.com)

Austria & Slovenia  
 Vienna: T +43/1 66 52 52 521 · [austria@endrich.com](mailto:austria@endrich.com)

Hungary:  
 Budapest: T +361 / 2 97 41 91 · [hungary@endrich.com](mailto:hungary@endrich.com)

Bulgaria:  
 Sofia: T +359/2 874 30 49 · [bulgaria@endrich.com](mailto:bulgaria@endrich.com)

Romania:  
 Timisoara: T +40/356 11 41 88 · [romania@endrich.com](mailto:romania@endrich.com)

Switzerland – Novitronic:  
 Zurich: T +41/44 306 91 91 · [info@novitronic.ch](mailto:info@novitronic.ch)

Spain:  
 Barcelona: T +34/93 217 31 44 · [spain@endrich.com](mailto:spain@endrich.com)